

www.drykj.com

更多选型请登陆官网



德润液压
DERUN HYDRAULIC

德润液压科技（常州）有限公司

Derun hydraulic technology (Changzhou) Co., Ltd.



专业高端液压缸制造商

Professional high-end hydraulic cylinder manufacturer

通过ISO9001-2008质量体系认证



Enterprises PROFILE

企业简介

德润液压科技(常州)有限公司是原(常州德润液压设备有限公司)增资(从新增资注册500万原注册100万)发展而来,是一家专业从事水泥建材行业、环保压滤行业、海事船舶行业、冶金行业、橡塑行业、采掘行业、港口机械行业、工程车辆行业、锻压机械行业液压油缸及液压系统研发与制造,公司地处沪宁铁路、沪宁高速公路罗墅湾出口500M,南邻京杭运河,西距常州民航机场800M。

德润液压拥有专业从事油缸开发、设计、制造、管理、服务的团队,能综合每一家主机厂对产品的需求,提出最优化的密封和强度等设计方案,更好地保证产品的可靠性和适用性。产品生产采用生产线制造模式,配以行业最先进生产工艺,更好地保证了产品的高品质和耐久性,从而赢得了国内外大批高端客户的高度认可,并与多家行业的领导企业建立了战略合作伙伴关系,本公司通过ISO9001-2008质量体系认证。

德润液压始终坚持“以市场为导向,以质量求生存,以创新求发展,诚信铸就辉煌”等经营理念,管理上以人为本,不断完善运作和管理机制,使公司持续健康发展。

Derun Hydraulic Technology (Changzhou) Co., Ltd. is the original (Changzhou De Run Hydraulic Equipment Co., Ltd.) capital increase (from the new capital registration 5 million registered 1 million) developed, is a professional cement building materials industry, environmental protection filter industry, maritime The company is located in Shanghai-Nanjing Railway, Shanghai-Nanjing Expressway Luo Shuwan export 500M, the company is located in the Shanghai-Nanjing Railway, the Shanghai-Nanjing Expressway, the shipbuilding industry, the rubber industry, the rubber industry, the mining industry, the port machinery industry, the engineering vehicle industry, the forging machinery industry hydraulic cylinder and hydraulic system R & D and manufacturing, South of Beijing-Hangzhou Grand Canal, west of Changzhou Civil Aviation Airport 800M.

DeRun hydraulic has a team specializing in cylinder development, design, manufacturing, management and service. It can integrate the demand of each main plant to the product and propose the optimal design of sealing and strength to ensure the reliability of the product and applicability. Production of production lines using the production model, coupled with the industry's most advanced production technology, and better to ensure that the products of high quality and durability, which won a large number of high-end customers at home and abroad a high degree of recognition, and with a number of industry leaders established Strategic partnership, the company passed ISO9001-2008 quality system certification. The following are the same as the "

German Run hydraulic always adhere to the "market-oriented, quality of survival, innovation and development, integrity cast brilliant" business philosophy, management people-oriented, and constantly improve the operation and management mechanism, the company sustained and healthy development



CONTENTS

 目录

-
- 01 水泥建材油缸
 - 02 立磨油缸
 - 03 液压油缸
 - 04 环保压滤油缸
 - 05 港口机械油缸
 - 06 挖泥船油缸
 - 07 冶金油缸
 - 08 液压系统
 - 09 千斤顶油缸
-

列车轮对压装机油缸

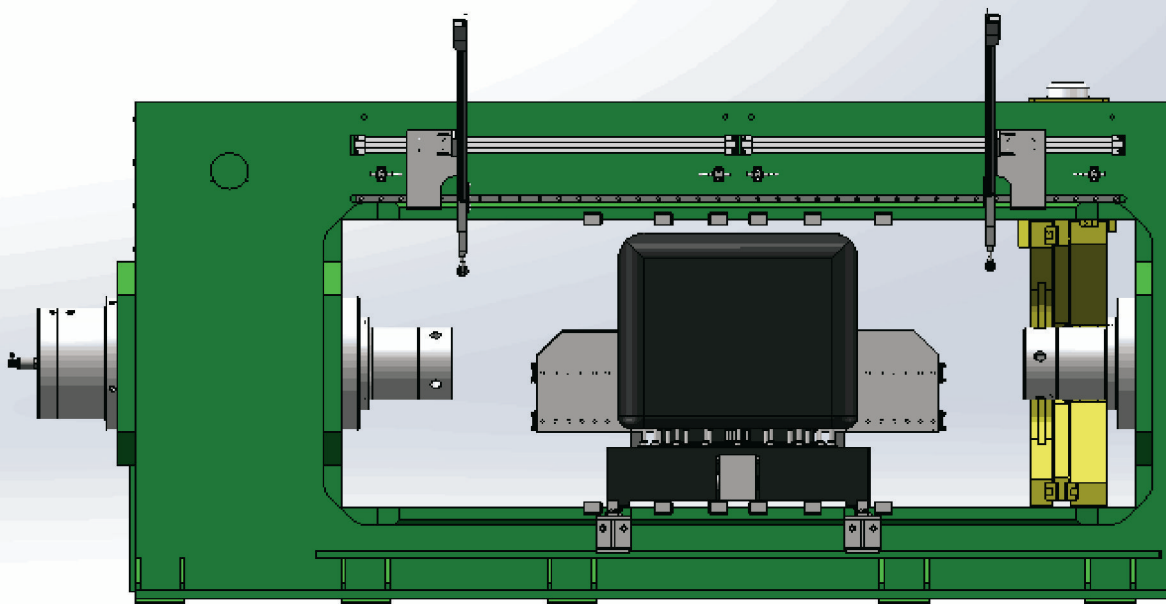

用德润人的精神
为客户提供专业化的产品性能

The spirit of Derun
To provide customers with professional product performance

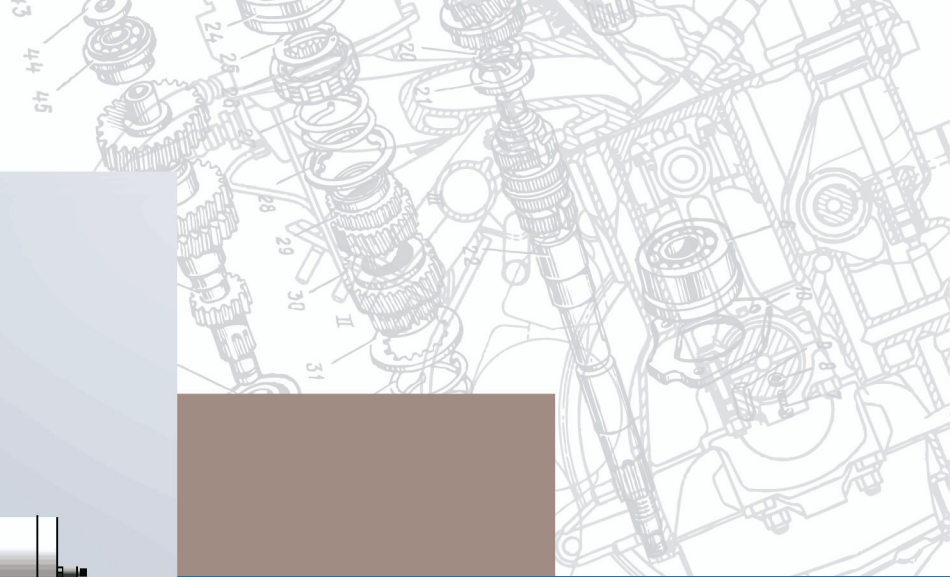
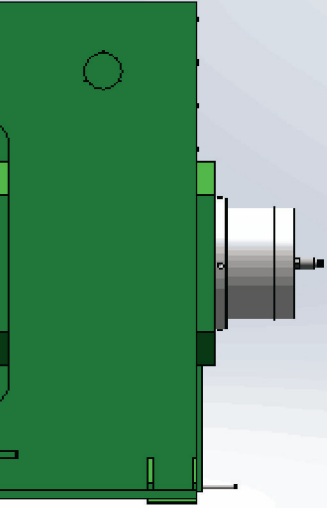

为客户提供全方位
优质专业的液压缸、液压系统设计与制造

To provide customers with all-round
High - quality professional hydraulic cylinder,
hydraulic system design





水泥建材油缸



辊压机油缸



辊压机油缸



篦冷机油缸



辊压机油缸



篦冷机油缸

辊压机油缸、篦冷机油缸工作环境恶劣，粉尘和碎石环境对活塞杆有强烈的磨损作用，振动冲击对于油缸的疲劳寿命有极高的要求。

德润辊压机具有非常突出的性能优点。通过在缸体内壁涂覆镀铬层，提高了缸体的耐磨性，在连续作业的情况下，大大提高了油缸的使用寿命。为了增加油缸的疲劳寿命，德润采用高强度的锻造材料、高频表面淬火以及有限元技术优化结构，减小应力集中。



立磨油缸



待发货水泥建材油缸



待油漆水泥建材油缸

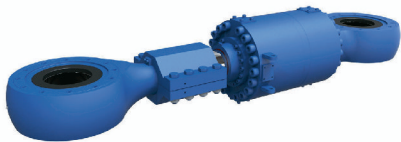

加压油缸



检修油缸

立磨油缸具有非常突出的性能优点。通过在缸体内壁涂覆镀铬层，提高了缸体的耐磨性，在连续作业的情况下，大大提高了油缸的使用寿命。为了增加油缸的疲劳寿命，采用高强度的锻造材料、高频表面淬火以及有限元技术优化结构，减小应力集中。



液压油缸



10000吨压机油缸(缸径1800mm) 500吨压机油缸

液压机速度大、冲击载荷大，因此对于油缸的疲劳强度、密封件的寿命、导向支撑机构都会有巨大的考验。

德润采用特殊的导向支撑设计，可以保证油缸可以承受巨大的侧向载荷，合理的结构设计确保油缸安全耐用、德润制造的最大的板压机油缸的缸径是1800mm，德润的制造装配能力可以确保该油缸具有足够精确的加工质量，从而保证油缸能够顺畅运行。

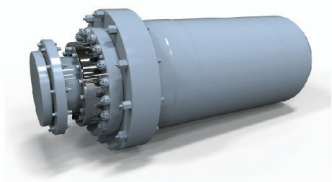

1000吨压机油缸

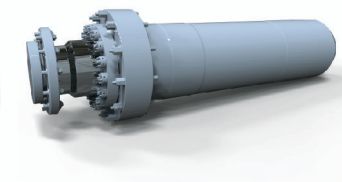

350吨压机油缸

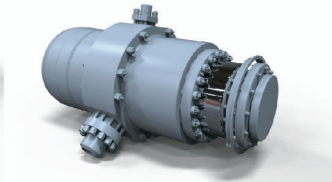

数字压机油缸

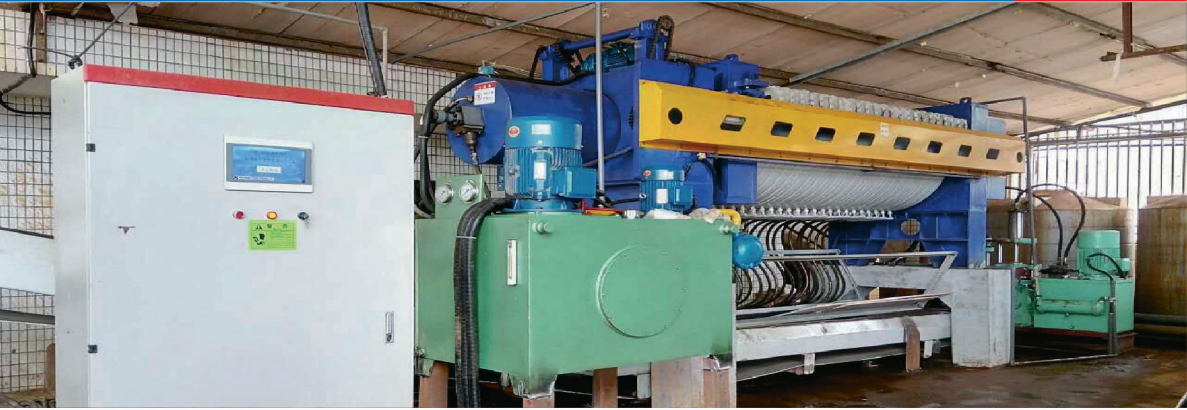

环保压滤油缸

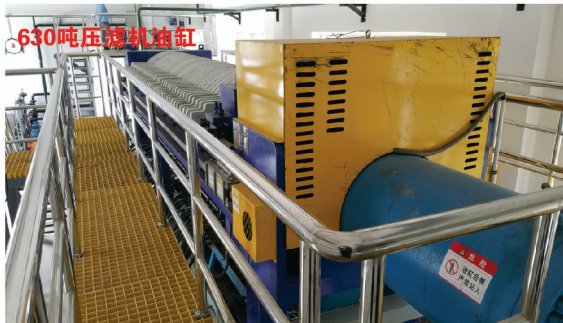
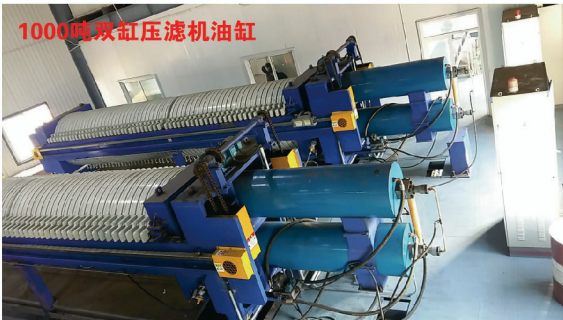



港口机械油缸



液压抓斗油缸

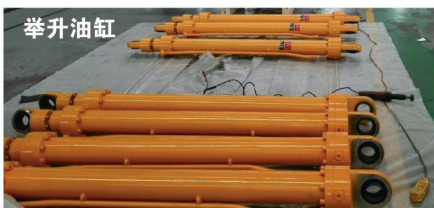

举升油缸



1000吨吊机变幅油缸

海洋的强腐蚀性环境对于海事和港口设备的抗腐蚀性能提出了挑战，德润经过多年的研发并引进顶尖的涂层技术、喷涂技术，可以保证在最严酷的环境下，德润油缸也能长时间可靠运行。我们与DNV、ABS、LR、GL、CCS等验证机构有多年的合作经验，同时为客户提供专项定制服务。一流的品质、专项定制方案、完善的售后服务让我们成为很多全球行业巨头的优秀供应商。主要应用于舱口盖及跳板控制、起重设备（港口和船舶）、波浪补偿设备、疏浚作业、管道铺设、打桩作业、钻探设备等。



德润液压科技（常州）有限公司

Derun hydraulic technology (Changzhou) Co., Ltd.



挖泥船油缸

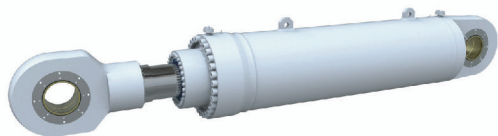

开口泥驳油缸



台车油缸



锁紧液压缸

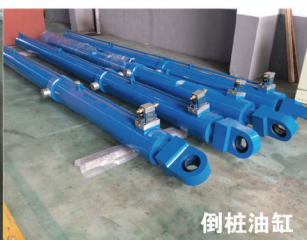

倒桩油缸

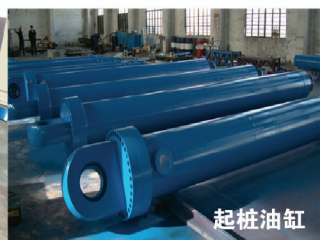

起桩油缸

疏浚可能是液压油缸最恶劣的作业环境之一，长期浸泡在水下环境、泥沙等沉淀物的侵蚀，都对液缸提出了非常苛刻的要求，德润油缸针对该环境特点，采用陶瓷活塞杆技术，具有超强的抗腐蚀特性和表面硬度，从而保证液缸能够长期稳定的工作，确保疏浚作业的效率。



冶金油缸



力士乐式油缸

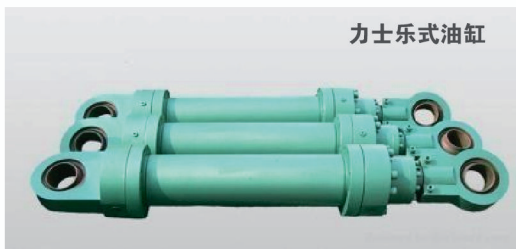

力士乐式油缸



冶金大包油缸



掌握制造工艺精髓的技术专家以及专业的车间工人完美地将设计转化为产品，先进的加工和检测设备更是我们产品持续保持高品质的坚强基础。

重载粉尘的采矿设备，高频高速、低摩擦要求的测试设备，我们在密封件结构设计、疲劳强度、涂层技术方面的丰富经验可以让我们的产品拥有更长久的使用寿命，更低的维护成本。



液压系统



德润液压系统专业制作各类非标及标准液压站等液压设备，广泛应用于重工、环保压滤、水利、物料输送、海事、机床、石油、压机、水泥、风电、盾构机、塑机、造纸及矿机等行业。

特色系统：

高低温液压系统、防爆液压系统、超高压液压系统、电液比例伺服液压系统、航空红油/蓝油液压系统、紧凑型动力单元。

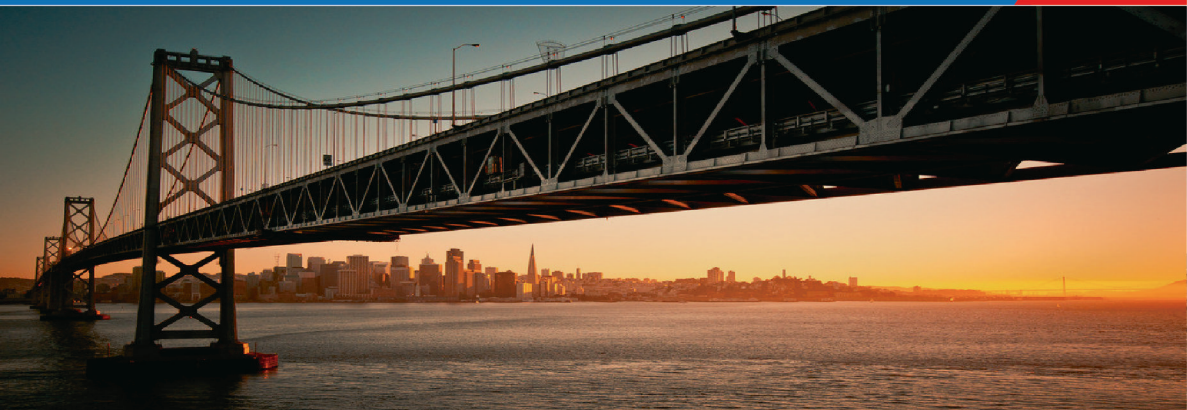

千斤顶油缸



千斤顶油缸需要可靠的液压油缸来保证工作可靠性。德润在设计方案过程中将油缸的安全性放在首要位置，同时考虑成本优化、疲劳强度等，在充分了解产品工作的极端工况和恶劣环境的基础上，德润设计的千斤顶油缸能充分满足客户的使用要求。



德润液压



大型抛光设备



大型自动埋弧焊机

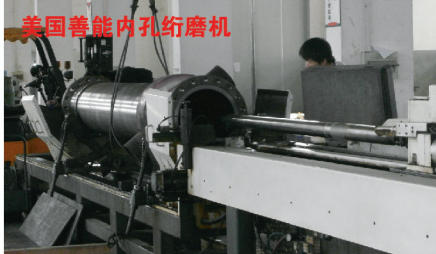

美国善能内孔珩磨机

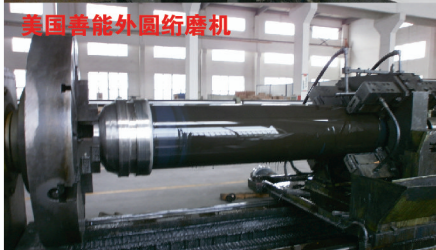

美国善能外圆珩磨机

合作共赢
Cooperation



德润液压

德润液压科技（常州）有限公司
Derun hydraulic technology (Changzhou) Co., Ltd.

www.dryykj.com

更多选型请登陆官网



德行天下 润泽四方



德润液压科技（常州）有限公司
Derun hydraulic technology (Changzhou) Co., Ltd.

地址：常州市新北区罗溪镇机场南路58号

电话：0519-83262105

传真：0519-83981301

联系人：朱先生

手机：18106117898 13685271508

邮箱：jszcc168@163.com